

**2955, 3055,
3155 and 3255
Tractors**

**TECHNICAL
MANUAL**

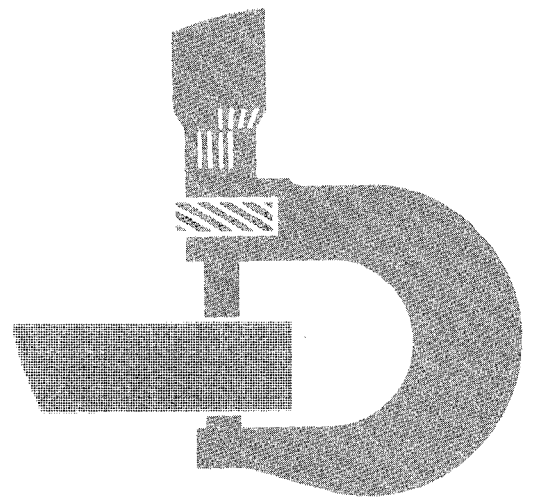

TM4449 (DEC-91)
LITHO IN U.S.A.

**2955, 3055, 3155 AND
3255 TRACTORS
TECHNICAL MANUAL
TM4449 (DEC-91)**

SECTION CONTENTS IN GROUPS – REPAIR

05 – SAFETY

10 – GENERAL

- 05 – Specifications
- 10 – Predelivery, delivery and after-sales inspections
- 15 – Lubrication and service
- 20 – Tune-up
- 25 – Tractor separation

20 – ENGINE, VISCOUS FAN DRIVE AND FAN

- 05 – Radiator, viscous fan drive and fan

30 – FUEL AND AIR INTAKE SYSTEM

- 05 – Fuel tank, auxiliary tank and water trap
- 10 – Cold weather starting aids
- 15 – Speed control linkage
- 20 – Air cleaner

40 – ELECTRICAL SYSTEM

- 05 – Wiring harnesses
- 10 – Controls and instruments (without SOUND-GARD body)
- 15 – Controls and instruments (with SOUND-GARD body)
- 20 – Lighting system
- 25 – Starting motor
- 30 – Alternator

50 – POWER TRAIN

- 05 – Clutch operating systems
- 10 – Engine clutch
- 15 – Hi-Lo shift unit
- 20 – Creeper transmission
- 25 – Transmission – console shift
- 30 – Transmission – center shift
- 35 – Synchronized transmission and transmission oil pump
- 40 – Differential
- 45 – Final drives
- 50 – PTO
- 55 – Front wheel drive u.j. drive shaft and disk clutch

60 – STEERING SYSTEM AND BRAKES

- 05 – Hydrostatic steering
- 10 – Steering cylinder (without front wheel drive)
- 15 – Hydraulic brakes
- 20 – Handbrake

70 – HYDRAULIC SYSTEM

- 05 – Valves
- 10 – Hydraulic pumps
- 15 – Rockshaft
- 25 – Selective control valves (spool type)
- 30 – Selective control valves (poppet valve type)

COPYRIGHT © 1991 DEERE & CO.
European Office Mannheim
All rights reserved
A John Deere ILLUSTRATION™ Manual
PREVIOUS EDITIONS
COPYRIGHT © 1987, 1989

INHALT-LB601AE-010991

SECTION CONTENTS IN GROUPS (REPAIR)

70 – HYDRAULIC SYSTEM (CONTD.)

- 35 – ISO breakaway couplers
- 40 – ISO quick couplers
- 45 – Remote cylinder

80 – MISCELLANEOUS

- 05 – Front axle
- 10 – Front and rear wheels

90 – OPERATOR'S STATION

- 05 – Safe handling of refrigerants
- 06 – Servicing air conditioning system
- 07 – Compressor (up to tractor serial no. 663 473L)
- 08 – Compressor (from tractor serial no. 663 474L)
- 09 – Components of air conditioning system
- 10 – Cab ventilation and heating
- 15 – Operator's seats
- 20 – SOUND-GARD body
- 25 – 4-post ROLL-GARD
- 30 – 2-post ROLL-GARD
- 35 – Foldable ROPS

INHALT-LB602AE-010991

**Thanks very much for your reading,
Want to get more information,
Please click here, Then get the complete
manual**

JustClickHere 

NOTE:

**If there is no response to click on the link above,
please download the PDF document first, and then
click on it.**

**Have any questions please write to me:
admin@servicemanualperfect.com**

SAFETY AND YOU

This is the safety-alert symbol. When you see this symbol on the machine or in this manual, be alert to the potential for personal injury.



T 81389

T81389;053;TMSAFE 19 07OCT85

IMPORTANT

The IMPORTANT message identifies potential problems which may cause consequential damage to machine. Following recommended procedure will instruct technician how to avoid problem.

A68;N01;0000 19 U 05NOV82

NOTES

The word NOTE is followed by a statement that identifies a qualification or exception to a previous statement. A "NOTE" may also identify nice-to-know information pertinent to, but not directly related to previous statement.

A68; N01;0000 19 V 05NOV82

HANDLE FLUIDS SAFELY – AVOID FIRES

When you work around fuel, do not smoke or work near heaters or other fire hazards.

Store flammable fluids away from fire hazards. Do not incinerate or puncture pressurized containers.

Make sure machine is clean of trash, grease, and debris.

Do not store oily rags; they can ignite and burn spontaneously.



TS 227

TS227-DX,FLAME-19-04JUN90

PREVENT BATTERY EXPLOSIONS

Keep sparks, lighted matches, and open flame away from the top of battery. Battery gas can explode.

Never check battery charge by placing a metal object across the posts. Use a volt-meter or hydrometer.

Do not charge a frozen battery; it may explode. Warm battery to 16°C (60°F).

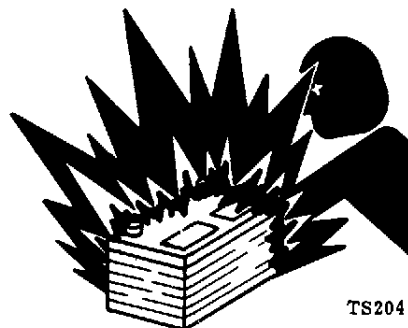

TS204

TS204-DX,SPARKS-19-04JUN90

PREPARE FOR EMERGENCIES

Be prepared if a fire starts.

Keep a first aid kit and fire extinguisher handy.

Keep emergency numbers for doctors, ambulance service, hospital, and fire department near your telephone.

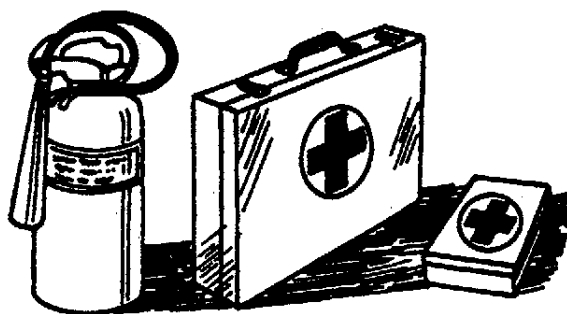

TS291

TS291-DX,FIRE2-19-04JUN90

PREVENT ACID BURNS

Sulfuric acid in battery electrolyte is poisonous. It is strong enough to burn skin, eat holes in clothing, and cause blindness if splashed into eyes.

Avoid the hazard by:

1. Filling batteries in a well-ventilated area.
2. Wearing eye protection and rubber gloves.
3. Avoiding breathing fumes when electrolyte is added.
4. Avoiding spilling or dripping electrolyte.
5. Use proper jump start procedure.

If you spill acid on yourself:

1. Flush your skin with water.
2. Apply baking soda or lime to help neutralize the acid.
3. Flush your eyes with water for 10–15 minutes. Get medical attention immediately.

If acid is swallowed:

1. Drink large amounts of water or milk.
2. Then drink milk of magnesia, beaten eggs, or vegetable oil.
3. Get medical attention immediately.

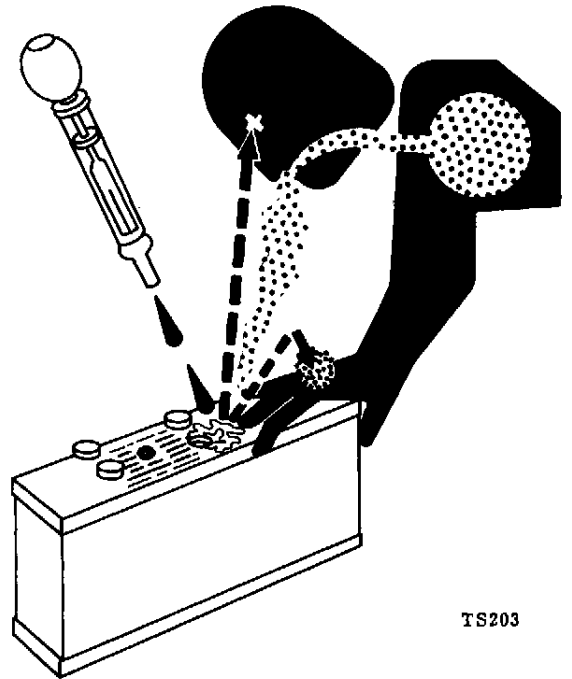

TS203

TS203-DX, POISON-19-04JUN90

AVOID HIGH-PRESSURE FLUIDS

Escaping fluid under pressure can penetrate the skin causing serious injury.

Avoid the hazard by relieving pressure before disconnecting hydraulic or other lines. Tighten all connections before applying pressure.

Search for leaks with a piece of cardboard. Protect hands and body from high pressure fluids.

If an accident occurs, see a doctor immediately. Any fluid injected into the skin must be surgically removed within a few hours or gangrene may result. Doctors unfamiliar with this type of injury should reference a knowledgeable medical source. Such information is available from Deere & Company Medical Department in Moline, Illinois, U.S.A.

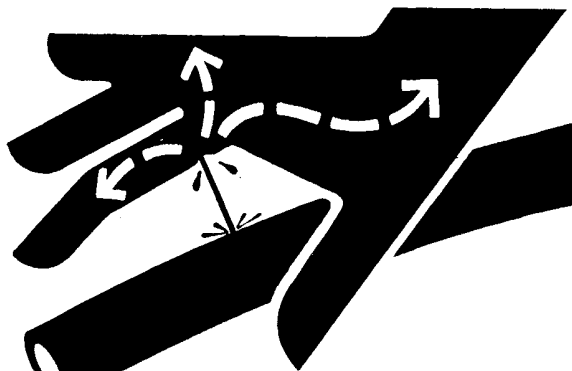

X9811-DX,FLUID-19-09AUG91

PARK MACHINE SAFELY

Before working on the machine:

- Lower all equipment to the ground.
- Stop the engine and remove the key.
- Disconnect the battery ground strap.
- Hang a "DO NOT OPERATE" tag in operator station.

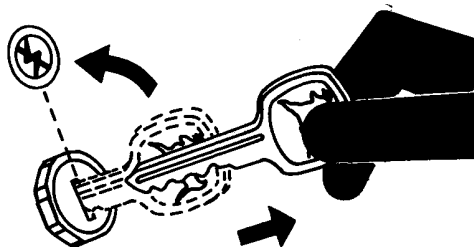

TS 230

TS230-DX,PARK-19-04JUN90

PREVENT MACHINE RUNAWAY

Avoid possible injury or death from machinery runaway.

Do not start engine by shorting across starter terminals. Machine will start in gear if normal circuitry is bypassed.

NEVER start engine while standing on ground. Start engine only from operator's seat, with transmission in neutral or park.



TS177

TS177-DX,BYPAS1-19-04JUN90

SUPPORT MACHINE PROPERLY

Always lower the attachment or implement to the ground before you work on the machine. If you must work on a lifted machine or attachment, securely support the machine or attachment.

Do not support the machine on cinder blocks, hollow tiles, or props that may crumble under continuous load. Do not work under a machine that is supported solely by a jack. Follow recommended procedures in this manual.

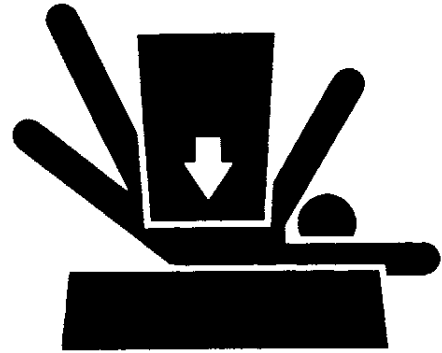

TS 229

TS229-DX,LOWER-19-04JUN90

SERVICE FRONT-WHEEL DRIVE TRACTOR SAFELY

When servicing front wheel drive tractor with the rear wheels supported off the ground and rotating wheels by engine power, always support front wheels in a similar manner. Loss of electrical power or transmission/hydraulic system pressure will engage the front driving wheels, pulling the rear wheels off the support if front wheels are not raised. Under these conditions, front drive wheels can engage even with switch in disengaged position.

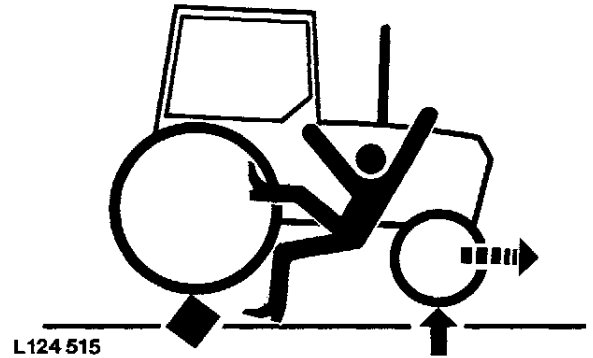

L124 515

L124515-LX.MFWD2-19-01MAY91

WEAR PROTECTIVE CLOTHING

Wear close fitting clothing and safety equipment appropriate to the job.

Prolonged exposure to loud noise can cause impairment or loss of hearing.

Wear a suitable hearing protective device such as earmuffs or earplugs to protect against objectionable or uncomfortable loud noises.

Operating equipment safely requires the full attention of the operator. Do not wear radio or music headphones while operating the machine.

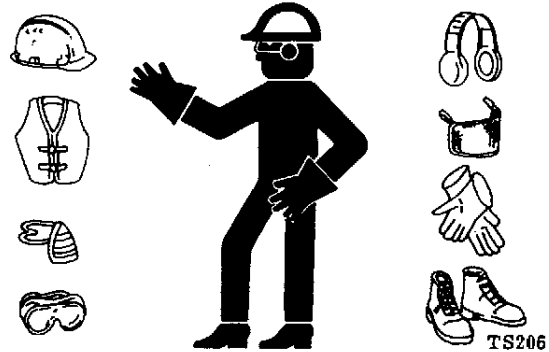

TS206-DX,WEAR-18-10SEP90

SERVICE MACHINES SAFELY

Tie long hair behind your head. Do not wear a necktie, scarf, loose clothing, or necklace when you work near machine tools or moving parts. If these items were to get caught, severe injury could result.

Remove rings and other jewelry to prevent electrical shorts and entanglement in moving parts.

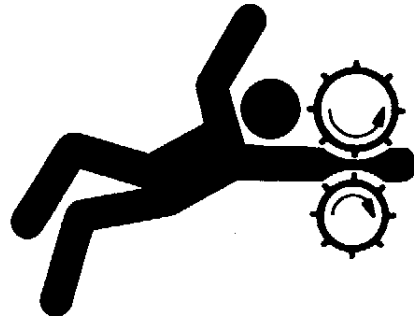

TS228-DX,LOOSE-19-04JUN90

WORK IN VENTILATED AREA

Engine exhaust fumes can cause sickness or death. If it is necessary to run an engine in an enclosed area, remove the exhaust fumes from the area with an exhaust pipe extension.

If you do not have an exhaust pipe extension, open the doors and get outside air into the area.

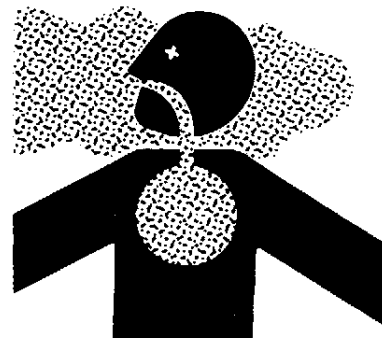

TS220-DX,AIR-19-04JUN90

WORK IN CLEAN AREA

Before starting a job:

- Clean work area and machine.
- Make sure you have all necessary tools to do your job.
- Have the right parts on hand.
- Read all instructions thoroughly; do not attempt shortcuts.

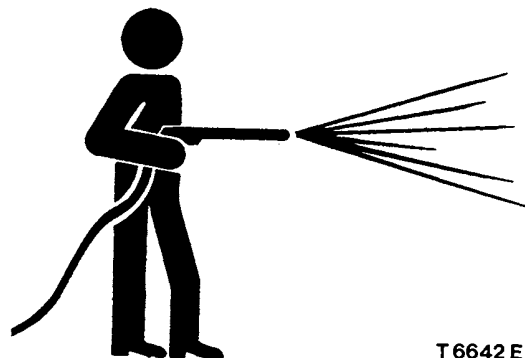

T 6642 E

T6642E-DX,CLEAN-19-04JUN90

REMOVE PAINT BEFORE WELDING OR HEATING

Avoid potentially toxic fumes and dust.

Hazardous fumes can be generated when paint is heated by welding, soldering, or using a torch.

Do all work outside or in a well ventilated area. Dispose of paint and solvent properly.

Remove paint before welding or heating:

- If you sand or grind paint, avoid breathing the dust. Wear an approved respirator.
- If you use solvent or paint stripper, remove stripper with soap and water before welding. Remove solvent or paint stripper containers and other flammable material from area. Allow fumes to disperse at least 15 minutes before welding or heating.



TS 220

TS220-DX,PAINT-19-04JUN90

AVOID HEATING NEAR PRESSURIZED FLUID LINES

Flammable spray can be generated by heating near pressurized fluid lines, resulting in severe burns to yourself and bystanders. Do not heat by welding, soldering, or using a torch near pressurized fluid lines or other flammable materials. Pressurized lines can be accidentally cut when heat goes beyond the immediate flame area.



TS 953

TS953-DX,TORCH-19-05OCT90

ILLUMINATE WORK AREA SAFELY

Illuminate your work area adequately but safely. Use a portable safety light for working inside or under the machine. Make sure the bulb is enclosed by a wire cage. The hot filament of an accidentally broken bulb can ignite spilled fuel or oil.

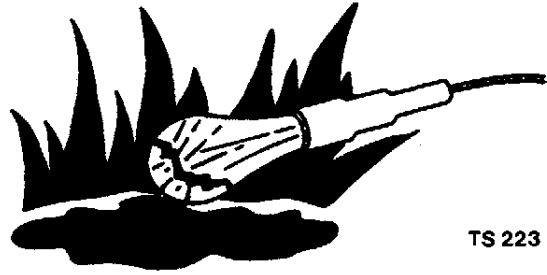

TS 223

TS223-DX,LIGHT-19-04JUN90

REPLACE SAFETY SIGNS

Replace missing or damaged safety signs. See the machine operator's manual for correct safety sign placement.



TS201

TS201-DX,SIGNS1-19-04JUN90

USE PROPER LIFTING EQUIPMENT

Lifting heavy components incorrectly can cause severe injury or machine damage.

Follow recommended procedure for removal and installation of components in the manual.

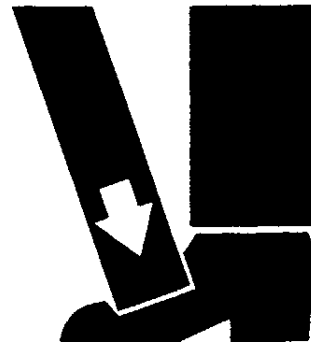

TS 226

TS226-DX,LIFT-19-04JUN90

KEEP ROPS INSTALLED PROPERLY

Make certain all parts are reinstalled correctly if the roll-over protective structure (ROPS) is loosened or removed for any reason. Tighten mounting bolts to proper torque.

The protection offered by ROPS is impaired if ROPS is subjected to structural damage, is involved in an overturn incident, or is in any way altered by welding, bending, drilling or cutting. A damaged ROPS should be replaced, not reused.

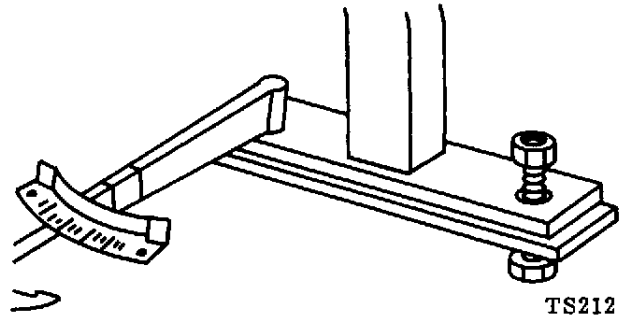

TS212-DX,ROPS3-19-04JUN90

SERVICE TIRES SAFELY

Explosive separation of a tire and rim parts can cause serious injury or death.

Do not attempt to mount a tire unless you have the proper equipment and experience to perform the job.

Always maintain the correct tire pressure. Do not inflate the tires above the recommended pressure. Never weld or heat a wheel and tire assembly. The heat can cause an increase in air pressure resulting in a tire explosion. Welding can structurally weaken or deform the wheel.

When inflating tires, use a clip-on chuck and extension hose long enough to allow you to stand to one side and NOT in front of or over the tire assembly. Use a safety cage if available.

Check wheels for low pressure, cuts, bubbles, damaged rims or missing lug bolts and nuts.

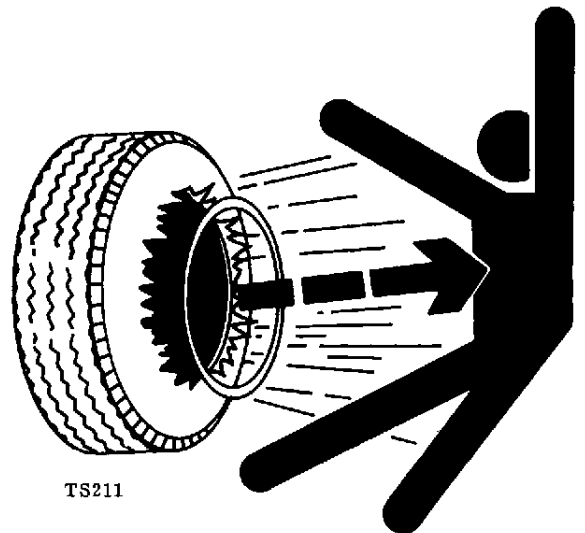

TS211-DX,RIM-19-24AUG90

AVOID HARMFUL ASBESTOS DUST

Avoid breathing dust that may be generated when handling components containing asbestos fibers. Inhaled asbestos fibers may cause lung cancer.

Components in John Deere products that may contain asbestos fibers are brake pads, brake band and lining assemblies, clutch plates and some gaskets. The asbestos used in these components is usually found in a resin or sealed in some way. Normal handling is not hazardous as long as airborne dust containing asbestos is not generated.

Avoid creating dust. Never use compressed air for cleaning. Avoid brushing or grinding material containing asbestos. When servicing, wear an approved respirator. A special vacuum cleaner is recommended to clean asbestos. If not available, apply a mist of oil or water on the material containing asbestos.

Keep bystanders away from the area.



TS 220

TS220-DX,DUST-19-15MAR91

PRACTICE SAFE MAINTENANCE

Understand service procedure before doing work. Keep area clean and dry.

Never lubricate or service machine while it is moving. Keep hands, feet, and clothing from power-driven parts. Disengage all power and operate controls to relieve pressure. Lower equipment to the ground. Stop the engine. Remove the key. Allow machine to cool.

Securely support any machine elements that must be raised for service work.

Keep all parts in good condition and properly installed. Fix damage immediately. Replace worn or broken parts. Remove any buildup of grease, oil, or debris.

Disconnect battery ground cable (-) before making adjustments or welding on machine.



TS 218

TS218-DX,SERV-19-04JUN90

USE PROPER TOOLS

Use tools appropriate to the work. Makeshift tools and procedures can create safety hazards.

Use power tools only to loosen threaded parts and fasteners.

For loosening and tightening hardware, use the correct size tools. **DO NOT** use U.S. measurement tools on metric fasteners. Avoid bodily injury caused by slipping wrenches.

Use only service parts meeting John Deere specifications.



TS779

TS779-DX,REPAIR-19-04JUN90

DISPOSE OF WASTE PROPERLY

Improperly disposing of waste can threaten the environment and ecology. Potentially harmful waste used with John Deere equipment include such items as oil, fuel, coolant, brake fluid, filters, and batteries.

Use leakproof containers when draining fluids. Do not use food or beverage containers that may mislead someone into drinking from them.

Do not pour waste onto the ground, down a drain, or into any water source.

Air conditioning refrigerants escaping into the air can damage the Earth's atmosphere. Government regulations may require a certified air conditioning service center to recover and recycle used air conditioning refrigerants.

Inquire on the proper way to recycle or dispose of waste from your local environmental or recycling center, or from your John Deere dealer.

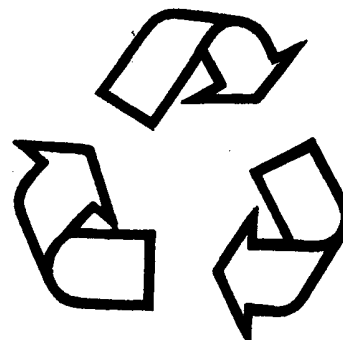

TS 1133

TS1133-DX,DRAIN-19-09AUG91

LIVE WITH SAFETY

Before returning machine to customer, make sure machine is functioning properly, especially the safety systems. Install all guards and shields.



TS 231

TS231-DX,LIVE-19-04JUN90

Section 10 GENERAL

05 – SPECIFICATIONS

Specifications	05-1
– Serial number plates	05-1
– Product identification number	05-1
– Engine serial number	05-1
– Transmission serial number	05-2
– Front wheel drive axle serial number	05-3
– SOUND-GARD body serial number	05-3
– ROLL-GARD serial number	05-3
– Model serial numbers	05-3
– Engine	05-4
– Engine clutch	05-5
– Cooling system	05-5
– Fuel system	05-5
– Electrical system	05-6
– Synchronized transmission	05-6
– Hi-Lo shift unit	05-6
– Creeper transmission	05-6
– Differential and final drives	05-6
– Differential lock	05-7
– PTO	05-7
– PTO speeds	05-7
– Front wheel drive	05-8
– Hydrostatic steering	05-8
– Foot brakes	05-8
– Hand brake	05-8
– Hydraulic system	05-8
– Rockshaft	05-8
– Ground travel speeds	05-8
– Front and rear wheels	05-9
– Dimensions and weights	05-9
– Capacities	05-9
– Standard torques for hardware	05-10

10 – PREDELIVERY, DELIVERY AND AFTER-SALES INSPECTIONS

Special tools	10-1
Specifications	10-2
Capacities	10-3
Torques for hardware	10-3
Preelivery inspection	10-4
Delivery inspection	10-24
After-sales inspection	10-25

15 – LUBRICATION AND SERVICE

Capacities and service intervals	15-1
Lubricants and service intervals	15-2
General	15-3
Diesel engine oil	15-3
Transmission/hydraulic oil	15-4
Oil for front wheel drive axle	15-4
EP multi-purpose grease	15-5
Storing lubricants	15-5
Brake fluid for hydraulic operated clutch	15-5
Alternative lubricants	15-6
Oil filters	15-6
Engine coolant	15-6
Liquid coolant conditioner	15-7
Checking engine oil level	15-7
Changing engine oil	15-8
Changing engine oil filter	15-8
Checking fuel filter	15-9
Replacing fuel filter	15-9
Replacing coolant	15-10
Checking transmission/hydraulic system oil level	15-11
Changing transmission/hydraulic oil	15-12
Replacing transmission/hydraulic oil filter element	15-13
Replacing hydraulic oil return flow filter	15-13
Replacing hydrostatic steering filter (without SOUND-GARD body or ROLL-GARD	15-14

ALLGEM-LB61001AE-010991

15 – LUBRICATION AND SERVICE (Contd.)

Cleaning hydraulic pump filter strainer	15-14
Replacing brake fluid (with hydraulic operated clutch)	15-14
Cleaning refrigerant and checking air conditioning system	15-15
Checking axle housing oil level	15-15
Checking oil level in wheel hub housings	15-15
Changing front axle oil	15-16
Cleaning lubricating points	15-16
Lubricating clutch throw-out bearing on mechanical operated clutch	15-16
Lubricating front axle and front wheel bearings (without front wheel drive)	15-17
Lubricating front axle (with front wheel drive)	15-17
Lubricating universal-jointed drive shaft (with front wheel drive)	15-18
Lubricating rear axle bearings	15-18
Lubricating three-point hitch	15-19

20 – TUNE-UP

Specifications	20-1
Preliminary engine testing	20-2
Checking air cleaner element	20-3
Checking air intake system connections for leaks	20-3
Checking crankcase vent tube for clogging	20-3
Cleaning radiator side panels and grille screens	20-3
Cleaning radiator and oil cooler	20-4
Cleaning condensor	20-4
Checking radiator cap	20-4
Checking radiator for leaks	20-4
Checking thermostats	20-5
Checking fuel transfer pump	20-5
Checking fuel filter	20-5
Checking fuel tank	20-6
Checking auxiliary fuel tank	20-6
Checking water trap	20-6
Checking fuel injection pump adjustment	20-6
Checking engine slow and fast idle speeds	20-7
Checking speed control linkage adjustment	20-8
Checking batteries	20-8
Checking fan belt tension	20-8
Checking compressor belt tension	20-9
Checking neutral start system	20-9
Checking operation of starting motor	20-9
Checking lighting system	20-10
Final engine check	20-10
Checking tractor operation	20-10

25 – TRACTOR SEPARATION

Special tools 25-1
Specifications 25-5
Torques for hardware 25-5
Capacities 25-9
Standard torques for hardware 25-10
Important notes 25-13
Removing tractor front end 25-14
Installing tractor front end 25-22
Separating between engine and clutch
housing 25-25
Joining tractor between engine and
clutch housing 25-36
Removing engine 25-40
Installing engine 25-41
Removing clutch housing 25-42
Installing clutch housing 25-44
Removing transmission 25-45
Installing transmission 25-55
Removing final drives 25-60
Installing final drives 25-70
Removing rockshaft 25-74
Installing rockshaft 25-77
Removing front axle 25-79
Installing front axle 25-80
Removing front wheel drive axle 25-83
Installing front wheel drive axle 25-85
Removing SOUND-GARD body or ROLL-GARD 25-87
Installing SOUND-GARD body or ROLL-GARD 25-97